



## MECHANICAL DEVICES FOR DIESEL ENGINES MANAGEMENT AND ORDER FORM MODEL SM 100T

### Characteristics:

Cable linear stroke in locking position: 20 mm

Assembly: on walls or on tubes

Fastening type: on walls, with flat bottom with two fastening screws

on tubes, with through screw protrusion 29 mm or 34 mm and high bottom

on tubes, with through screw protrusion 29 mm or 34 mm and short bottom

on tubes, with nylon collar for tube outer diameter 22 mm - 25 mm - 26 mm - 27 mm - 28 mm

Lever functioning: free with locking at stroke end    Material: nylon    Little lever colour: red    Holder colour: black

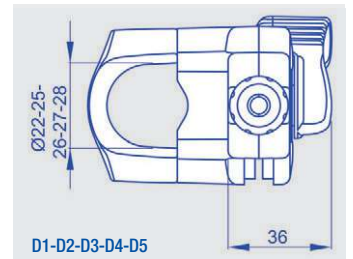
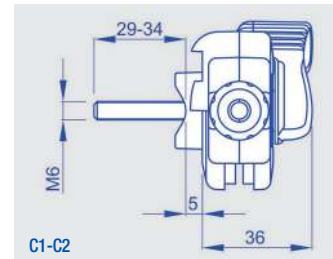
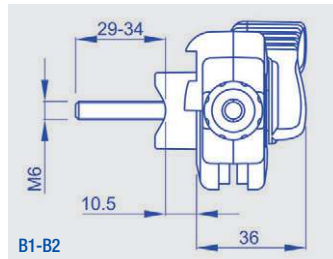
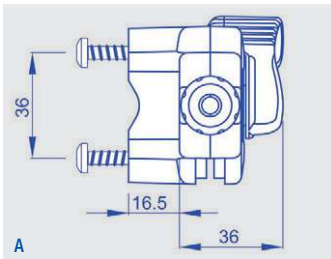
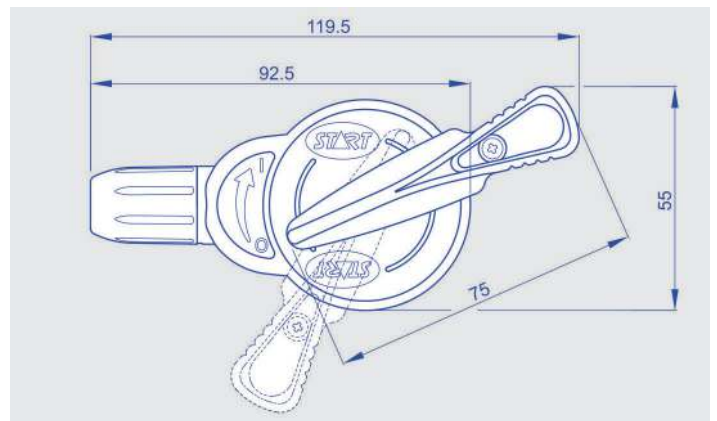

**To order: compose, please, your product code inserting the boldfaced code corresponding to the chosen option in the proper square.**

SM 100T

Wall fastening with flat bottom and two fastening screws: **A**

Tube fastening with through screw protrusion 29 mm and high bottom (for tubes up to D.22 mm): **B1**

Tube fastening with through screw protrusion 34 mm and high bottom (for tubes up to D.28 mm): **B2**

Tube fastening with through screw protrusion 29 mm and short bottom (for tubes up to D.22 mm): **C1**

Tube fastening with through screw protrusion 34 mm and short bottom (for tubes up to D.28 mm): **C2**

Tube fastening with collar Ø 22 mm: **D1**

Tube fastening with collar Ø 25 mm: **D2**

Tube fastening with collar Ø 26 mm: **D3**

Tube fastening with collar Ø 27 mm: **D4**

Tube fastening with collar Ø 28 mm: **D5**





## MECHANICAL DEVICES COMPATIBLE CABLES MODEL SM 100T

### Characteristics:

Sheath diameter: Ø5 mm with inner antifriction tube  
 Sheath length: upon request  
 Wire diameter: Ø1,2 mm or Ø1,6 mm  
 Wire protrusion length: upon request  
 Sheath terminals: see table  
 Wire terminals: see table

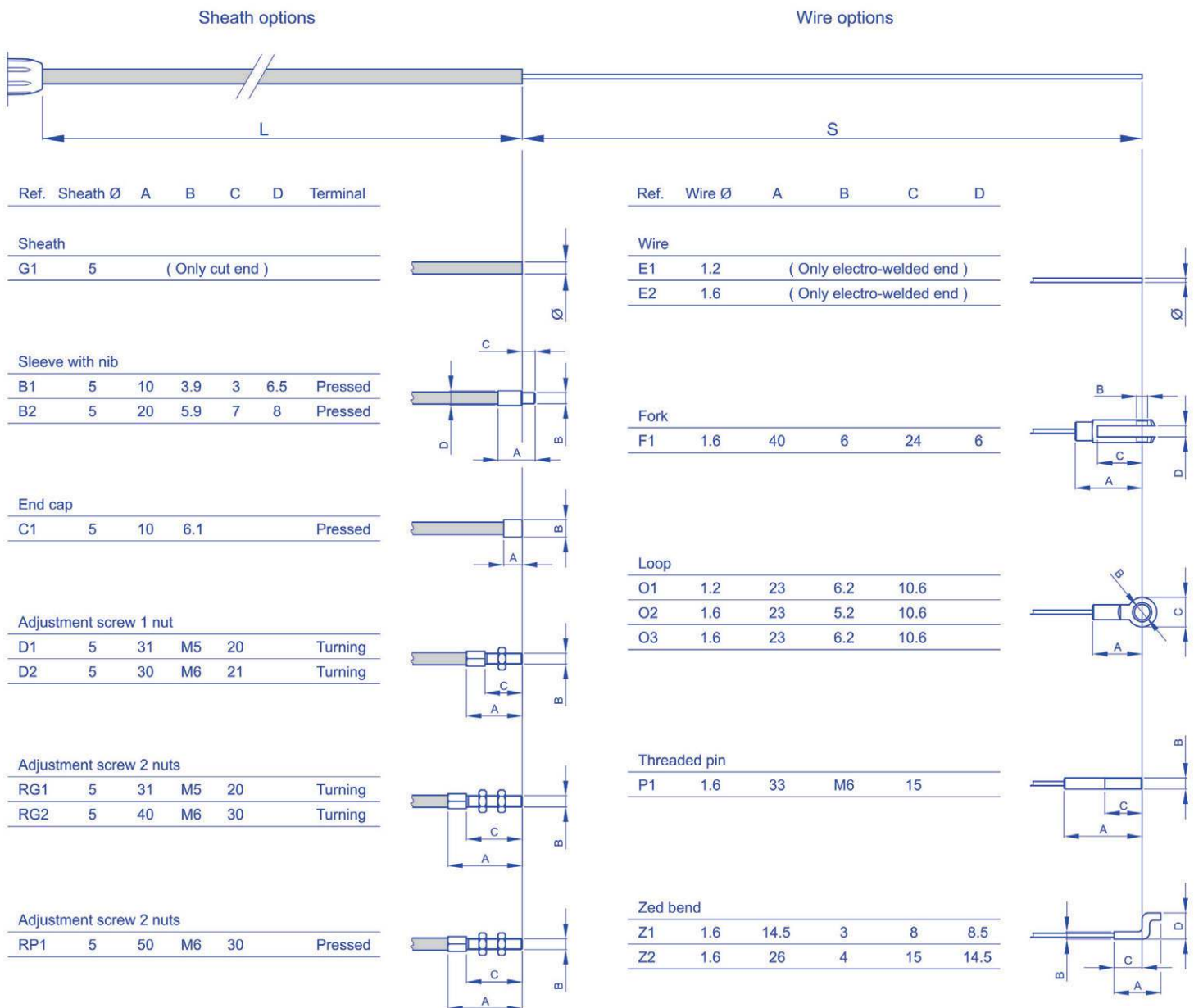



## MECHANICAL DEVICES ORDER FORM FOR COMPATIBLE CABLES MODEL SM 100T

**To order:**

The technical options that are represented on the opposite page are the standard personalizations which are provided from the company.

Among these possibilities, you can choose the cable construction that meets your requirements.

At first choose the sheath terminals among the possible options.

Find out your preferences and fill in the boxes with the number or the letters/number corresponding to your options.

Example: if you choose a sleeve with nib as terminal, indicate the code 02 or 03, according to your needs.

And so on for other variables.

The same procedure must be used to choose the wire: start choosing the diameter and then select the corresponding options.

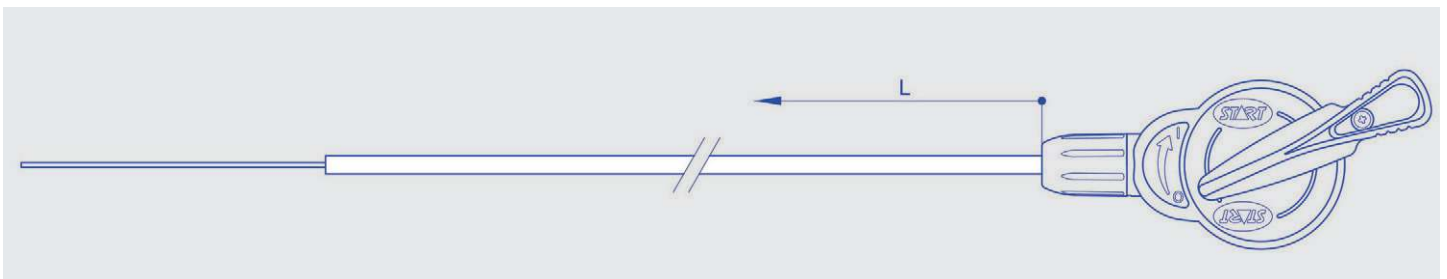

**To order: compose, please, your product code inserting the boldfaced code corresponding to the chosen option in the proper square.**

Cable							
-------	--	--	--	--	--	--	--

<p>Sheath length (L) in mm: _____</p> <p>Wire protrusion length (S) in mm: _____</p> <p>Sheath Ø5 mm (only cut) G1: <b>01</b> _____</p> <p>Sleeve with nib B1: <b>02</b> } _____</p> <p>Sleeve with nib B2: <b>03</b> } _____</p> <p>End cap C1: <b>04</b> _____</p> <p>Turning adjustment screw 1 nut D1: <b>05</b> } _____</p> <p>Turning adjustment screw 1 nut D2: <b>06</b> } _____</p> <p>Turning adjustment screw 2 nuts RG1: <b>07</b> } _____</p> <p>Turning adjustment screw 2 nuts RG2: <b>08</b> } _____</p> <p>Pressed adjustment screw 2 nuts RP1: <b>09</b> _____</p>	<p>Only electro-welded wire Ø1,2 mm without terminal E1: <b>10</b></p> <p>Only electro-welded wire Ø1,6 mm without terminal E2: <b>11</b></p> <p>_____ Fork F1: <b>12</b></p> <p>_____ } Loop O1: <b>13</b></p> <p>_____ } Loop O2: <b>14</b></p> <p>_____ } Loop O3: <b>15</b></p> <p>_____ Threaded pin P1: <b>16</b></p> <p>_____ } Zed bend Z1: <b>17</b></p> <p>_____ } Zed bend Z2: <b>18</b></p>
--	---