

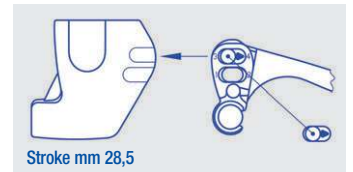

SINGLE MECHANICAL LEVERS WITH DIRECT ACTING AND ORDER FORM MODEL LA 200

Characteristics:

- Linear stroke: 18 - 21 - 25 - 28,5 mm (changeable in action)
- Assembly: on tubes
- Fastening type: nylon collar
- Tube outer diameter: 22 mm - 25 mm - 26 mm - 27 mm - 28 mm
- Material: nylon
- Lever colour: black - red - yellow
- Holder colour: black

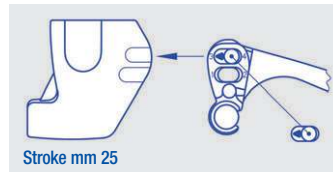
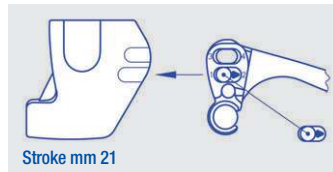
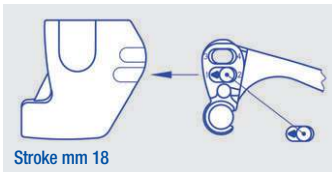
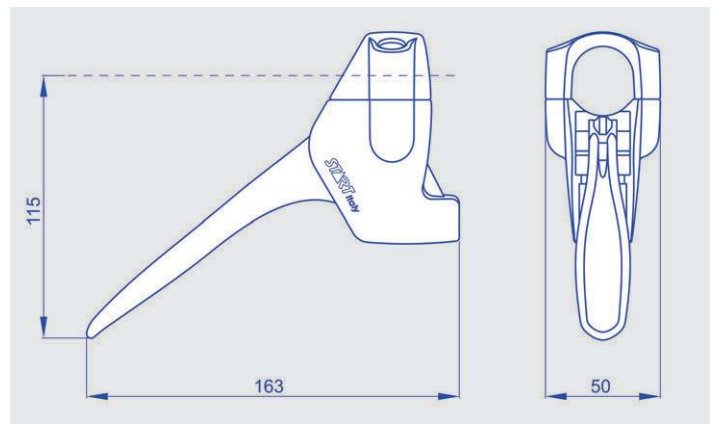

To order: compose, please, your product code inserting the boldfaced code corresponding to the chosen option in the proper square.

LA 200

- Stroke mm 18: **1**
- Stroke mm 21: **2**
- Stroke mm 25: **3**
- Stroke mm 28,5: **4**

- Outer tube Ø mm 22: **5**
- Outer tube Ø mm 25: **6**
- Outer tube Ø mm 26: **7**
- Outer tube Ø mm 27: **8**
- Outer tube Ø mm 28: **9**

- Black lever: **N**
- Red lever: **R**
- Yellow lever: **G**



SINGLE MECHANICAL LEVERS - COMPATIBLE CABLES

MODELS LA 100 - LA 150 - LA 200 - LV 900 - LV 26 - LV 30 - LA 200B LA 100S - LA 100SR - LA 150S - LA 200S - LV 901 - LVS 28 - LV 30S

Characteristics:

Sheath diameter: Ø6 mm or Ø7 mm with inner antifriction tube

Sheath length: upon request

Wire diameter: Ø1,9 mm or Ø2,5 mm

Wire protrusion length: upon request

Sheath terminals: see table

Wire terminals: see table

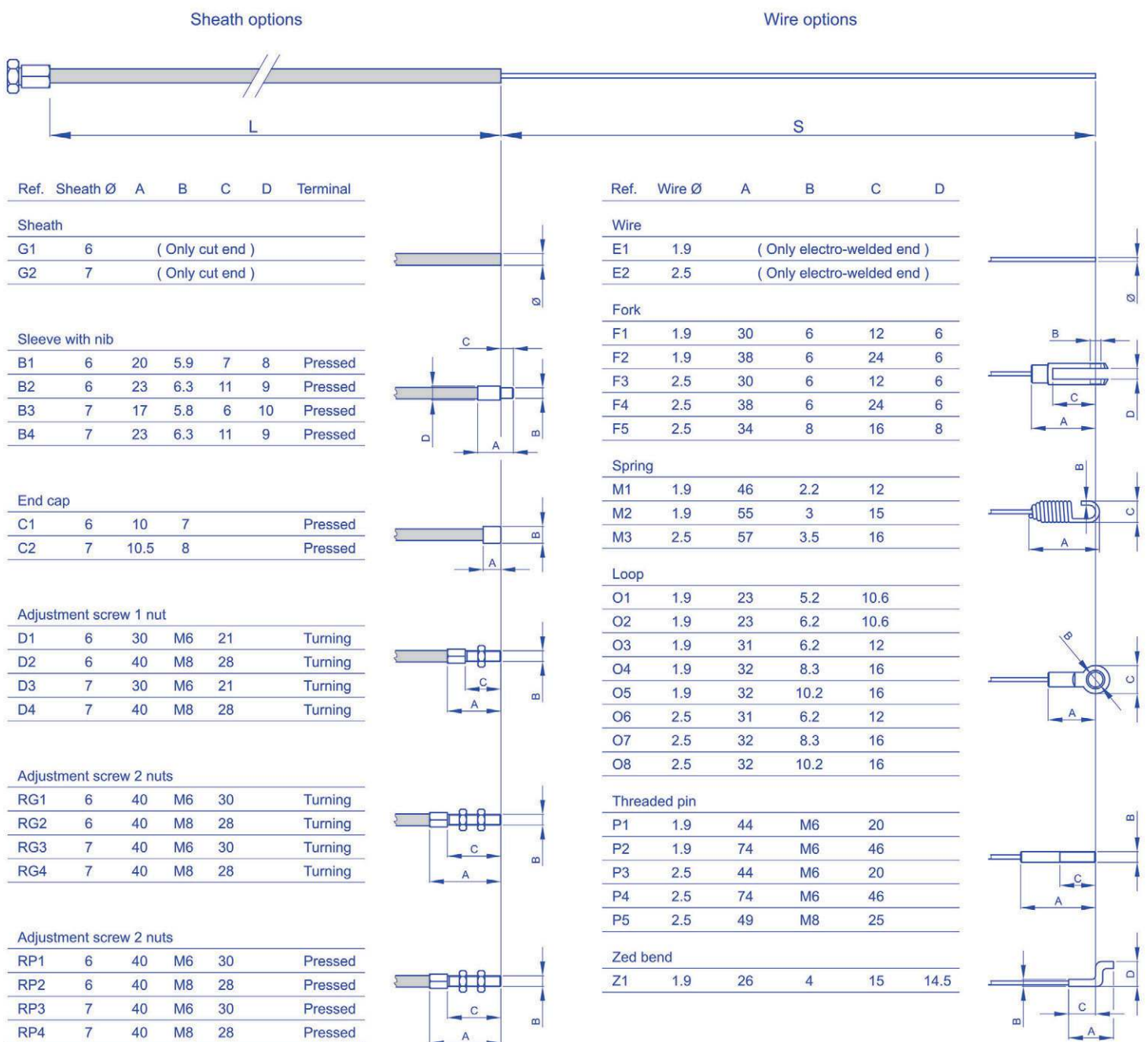



SINGLE MECHANICAL LEVERS - ORDER FORM FOR COMPATIBLE CABLES

MODELS LA 100 - LA 150 - LA 200 - LV 900 - LV 26 - LV 30 - LA 200B LA 100S - LA 100SR - LA 150S - LA 200S - LV 901 - LVS 28 - LV 30S

To order:

The technical options that are represented on the opposite page are the standard personalizations which are provided from the company.

Among these possibilities, you can choose the cable construction that meets your requirements.

At first choose the sheath diameter and select the corresponding terminals among the possible options.

Find out your preferences and fill in the boxes with the number or the letters/number corresponding to your options.

Example: if you choose a \varnothing 7 mm sheath and you want a sleeve with nib as terminal, indicate the code 05 or 06, according to your needs.

And so on for other variables.

The same procedure must be used to choose the wire: start choosing the diameter and then select the corresponding options.

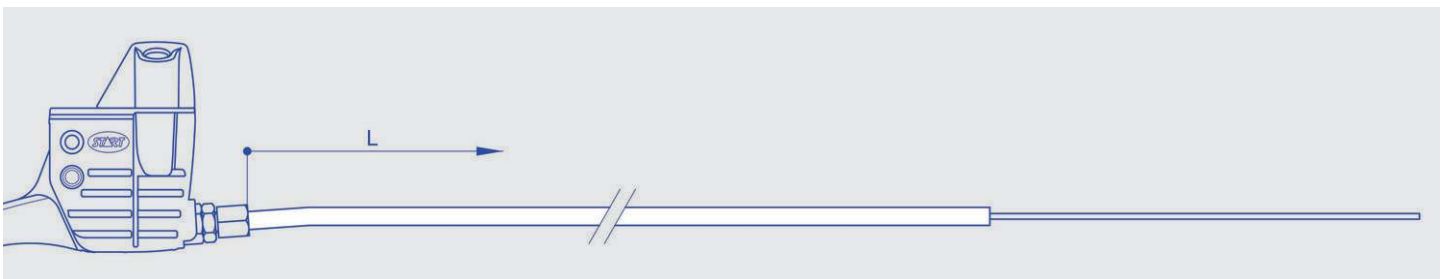

To order: compose, please, your product code inserting the boldfaced code corresponding to the chosen option in the proper square.

Cable							
-------	--	--	--	--	--	--	--

<p>Sheath length (L) in mm: _____</p> <p>Wire protrusion length (S) in mm: _____</p> <p>Sheath \varnothing 6 mm (only cut) G1: 01</p> <p>Sheath \varnothing 7 mm (only cut) G2: 02</p> <p>Sleeve with nib B1: 03</p> <p>Sleeve with nib B2: 04</p> <p>Sleeve with nib B3: 05</p> <p>Sleeve with nib B4: 06</p> <p>End cap C1: 07</p> <p>End cap C2: 08</p> <p>Adjustment screw 1 nut D1: 09</p> <p>Adjustment screw 1 nut D2: 10</p> <p>Adjustment screw 1 nut D3: 11</p> <p>Adjustment screw 1 nut D4: 12</p> <p>Turning adjustment screw 2 nuts RG1: 13</p> <p>Turning adjustment screw 2 nuts RG2: 14</p> <p>Turning adjustment screw 2 nuts RG3: 15</p> <p>Turning adjustment screw 2 nuts RG4: 16</p> <p>Pressed adjustment screw 2 nuts RP1: 17</p> <p>Pressed adjustment screw 2 nuts RP2: 18</p> <p>Pressed adjustment screw 2 nuts RP3: 19</p> <p>Pressed adjustment screw 2 nuts RP4: 20</p>	<p>Only electro-welded wire \varnothing 1,9 mm without terminal E1: 21</p> <p>Only electro-welded wire \varnothing 2,5 mm without terminal E2: 22</p> <p>Fork F1: 23</p> <p>Fork F2: 24</p> <p>Fork F3: 25</p> <p>Fork F4: 26</p> <p>Fork F5: 27</p> <p>Spring M1: 28</p> <p>Spring M2: 29</p> <p>Spring M3: 30</p> <p>Loop O1: 31</p> <p>Loop O2: 32</p> <p>Loop O3: 33</p> <p>Loop O4: 34</p> <p>Loop O5: 35</p> <p>Loop O6: 36</p> <p>Loop O7: 37</p> <p>Loop O8: 38</p> <p>Threaded pin P1: 39</p> <p>Threaded pin P2: 40</p> <p>Threaded pin P3: 41</p> <p>Threaded pin P4: 42</p> <p>Threaded pin P5: 43</p> <p>Zed bend Z1: 44</p>
--	---

L = start point for sheath length. Other cables typologies are available upon request.