

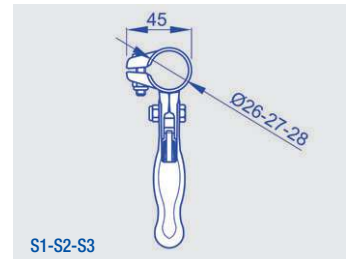

## COMBINABLE MECHANICAL LOWER SINGLE LEVERS WITH DIRECT ACTING OR WITH LOCKING AND ORDER FORM COMBINATION DS 01 / LV 26

### Characteristics:

- Linear stroke in direct acting: 19 mm
- Linear stroke in locking position: 17 mm
- Locking: to be inserted manually or to be inserted automatically
- Assembly: on tubes
- Fastening type: holder to be soldered, raw (to allow the welding) or metal hose clamp, right or left
- Tube outer diameter: 22 mm - 26 mm - 27 mm - 28 mm
- Material: metal Metal treatment: zinc plated

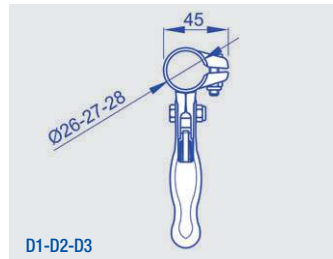
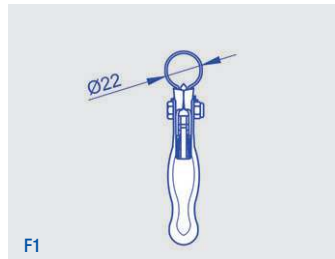
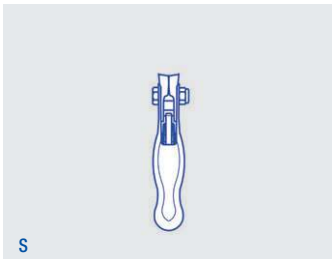
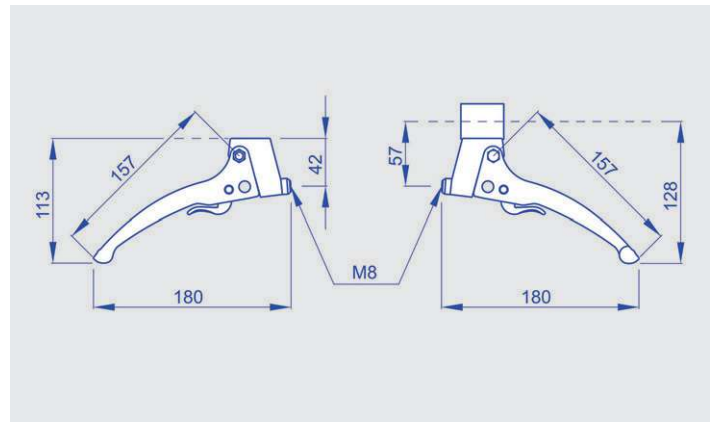

To order: compose, please, your product code inserting the boldfaced code corresponding to the chosen option in the proper square.

LV 26 comb.

- Stroke mm 19 in direct acting: **D**
- Stroke mm 17 with manual locking trigger: **M**
- Stroke mm 17 with automatic locking trigger: **A**

- Holder to be soldered: **S**
- Metal hose clamp for outer tube Ø mm 22: **F1**
- Right metal hose clamp for outer tube Ø mm 26: **D1**
- Right metal hose clamp for outer tube Ø mm 27: **D2**
- Right metal hose clamp for outer tube Ø mm 28: **D3**
- Left metal hose clamp for outer tube Ø mm 26: **S1**
- Left metal hose clamp for outer tube Ø mm 27: **S2**
- Left metal hose clamp for outer tube Ø mm 28: **S3**



## COMBINABLE MECHANICAL LEVERS COMPATIBLE WITH LOWER LEVER CABLES MODELS LV 26 - LV 30

### Characteristics:

Sheath diameter: Ø6 mm or Ø7 mm with inner antifriction tube

Sheath length: upon request

Wire diameter: Ø1,9 mm or Ø2,5 mm

Wire protrusion length: upon request

Sheath terminals: see table

Wire terminals: see table

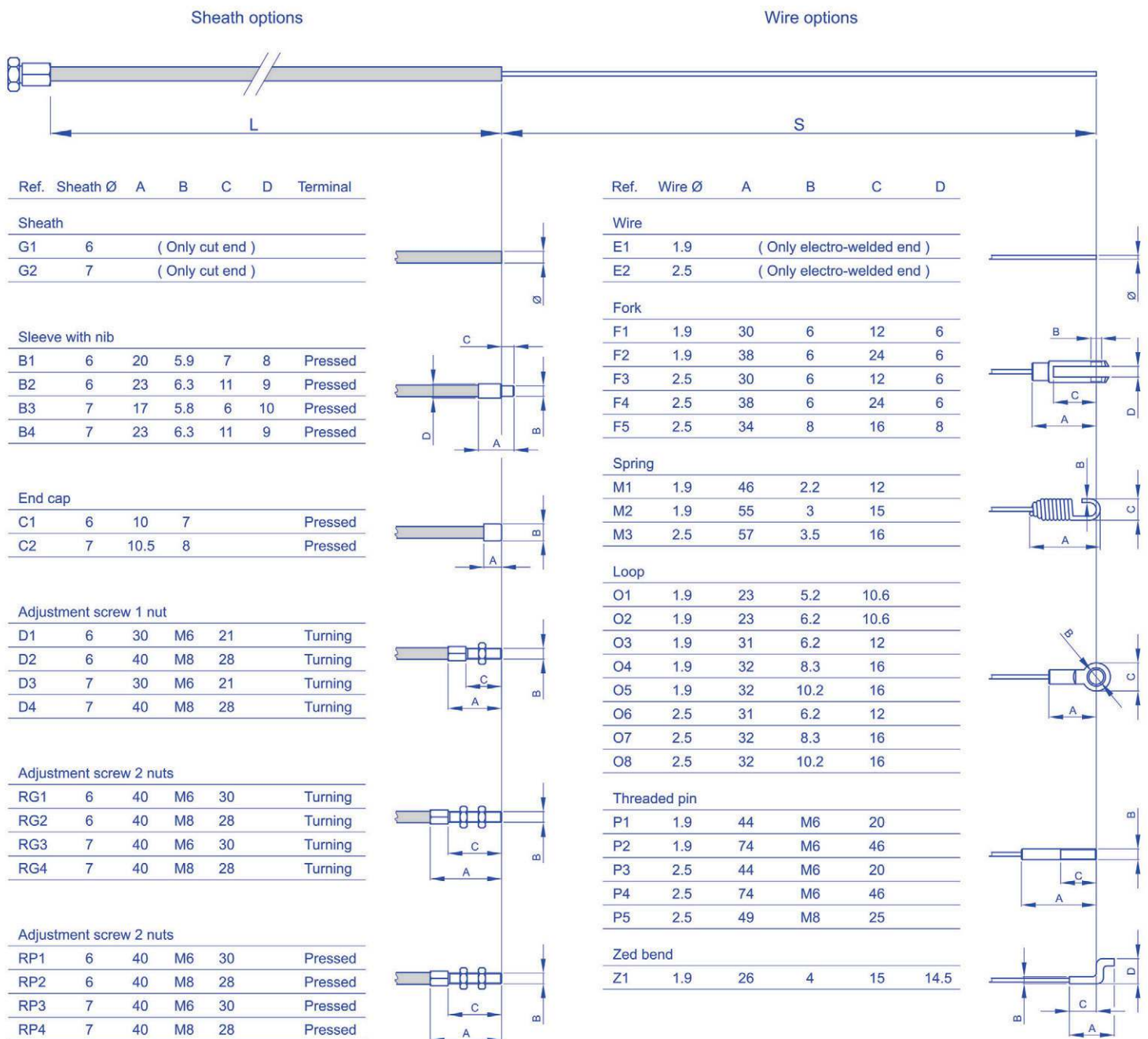



## COMBINABLE MECHANICAL LEVERS ORDER FORM FOR COMPATIBLE WITH LOWER LEVER CABLES MODELS LV 26 - LV 30

**To order:**

The technical options that are represented on the opposite page are the standard personalizations which are provided from the company.

Among these possibilities, you can choose the cable construction that meets your requirements.

At first choose the sheath diameter and select the corresponding terminals among the possible options.

Find out your preferences and fill in the boxes with the number or the letters/number corresponding to your options.

Example: if you choose a Ø7 mm sheath and you want a sleeve with nib as terminal, indicate the code 05 or 06, according to your needs.

And so on for other variables.

The same procedure must be used to choose the wire: start choosing the diameter and then select the corresponding options.

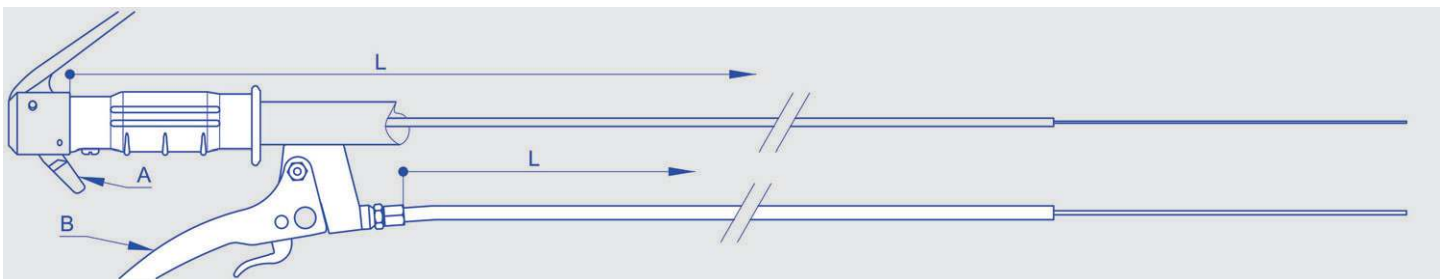

**To order: compose, please, your product code inserting the boldfaced code corresponding to the chosen option in the proper square.**

<b>Lever B cable</b>									
----------------------	--	--	--	--	--	--	--	--	--

<p>Sheath length (L) in mm: _____</p> <p>Wire protrusion length (S) in mm: _____</p> <p>Sheath Ø6 mm (only cut) G1: <b>01</b></p> <p>Sheath Ø7 mm (only cut) G2: <b>02</b></p> <p>Sleeve with nib B1: <b>03</b></p> <p>Sleeve with nib B2: <b>04</b></p> <p>Sleeve with nib B3: <b>05</b></p> <p>Sleeve with nib B4: <b>06</b></p> <p>End cap C1: <b>07</b></p> <p>End cap C2: <b>08</b></p> <p>Adjustment screw 1 nut D1: <b>09</b></p> <p>Adjustment screw 1 nut D2: <b>10</b></p> <p>Adjustment screw 1 nut D3: <b>11</b></p> <p>Adjustment screw 1 nut D4: <b>12</b></p> <p>Turning adjustment screw 2 nuts RG1: <b>13</b></p> <p>Turning adjustment screw 2 nuts RG2: <b>14</b></p> <p>Turning adjustment screw 2 nuts RG3: <b>15</b></p> <p>Turning adjustment screw 2 nuts RG4: <b>16</b></p> <p>Pressed adjustment screw 2 nuts RP1: <b>17</b></p> <p>Pressed adjustment screw 2 nuts RP2: <b>18</b></p> <p>Pressed adjustment screw 2 nuts RP3: <b>19</b></p> <p>Pressed adjustment screw 2 nuts RP4: <b>20</b></p>	<p>Only electro-welded wire Ø 1,9 mm without terminal E1: <b>21</b></p> <p>Only electro-welded wire Ø 2,5 mm without terminal E2: <b>22</b></p> <p>Fork F1: <b>23</b></p> <p>Fork F2: <b>24</b></p> <p>Fork F3: <b>25</b></p> <p>Fork F4: <b>26</b></p> <p>Fork F5: <b>27</b></p> <p>Spring M1: <b>28</b></p> <p>Spring M2: <b>29</b></p> <p>Spring M3: <b>30</b></p> <p>Loop O1: <b>31</b></p> <p>Loop O2: <b>32</b></p> <p>Loop O3: <b>33</b></p> <p>Loop O4: <b>34</b></p> <p>Loop O5: <b>35</b></p> <p>Loop O6: <b>36</b></p> <p>Loop O7: <b>37</b></p> <p>Loop O8: <b>38</b></p> <p>Threaded pin P1: <b>39</b></p> <p>Threaded pin P2: <b>40</b></p> <p>Threaded pin P3: <b>41</b></p> <p>Threaded pin P4: <b>42</b></p> <p>Threaded pin P5: <b>43</b></p> <p>Zed bend Z1: <b>44</b></p>
------------------------------------------------------------------------------------------------------------------------------------------------------------------------------------------------------------------------------------------------------------------------------------------------------------------------------------------------------------------------------------------------------------------------------------------------------------------------------------------------------------------------------------------------------------------------------------------------------------------------------------------------------------------------------------------------------------------------------------------------------------------------------------------------------------------------------------------------------------------------------------------------------------------------------------------------------------------------------------------------------------------------------	-----------------------------------------------------------------------------------------------------------------------------------------------------------------------------------------------------------------------------------------------------------------------------------------------------------------------------------------------------------------------------------------------------------------------------------------------------------------------------------------------------------------------------------------------------------------------------------------------------------------------------------------------------------------------------------------------------------------------------------------------------------------------------------------------

L = start point for sheath length. Other cables typologies are available upon request.