



COMBINED ELECTRIC / MECHANICAL CONTROLS FOR PETROL MOTORSTOP, ENGAGED CLUTCH WITH ELECTRIC CABLE INSIDE THE TUBE AND ORDER FORM MODEL CL 10B

Characteristics:

Control functioning: the levers are in dependent acting. The upper lever A is kept activated (lowered) if the lower lever B is in locking position.

Application example: deadman device (engine switching off – lever A) combined with clutch lever control (lever B)

Upper lever A electric contact: normally open or normally closed microswitch (see note)

Lower lever B linear stroke in locking position (mm): 17

Lever A material and colour: red nylon; holder in aluminium or in black nylon

Assembly: on tubes

Lever A fastening type: with screw

Nib diameter for lever A (see note)

Lower lever B material and treatment: zinc plated metal; holder zinc plated metal

Assembly: on tubes

Lever B fastening type: holder to be soldered, raw - metal hose clamp, right or left

Tube outer diameter for lever B (mm): 22 - 26 - 27 - 28

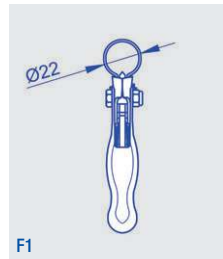
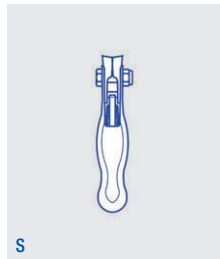
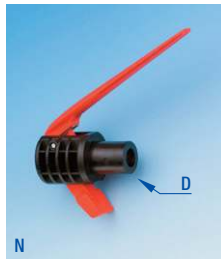
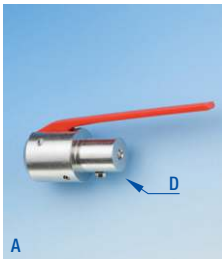
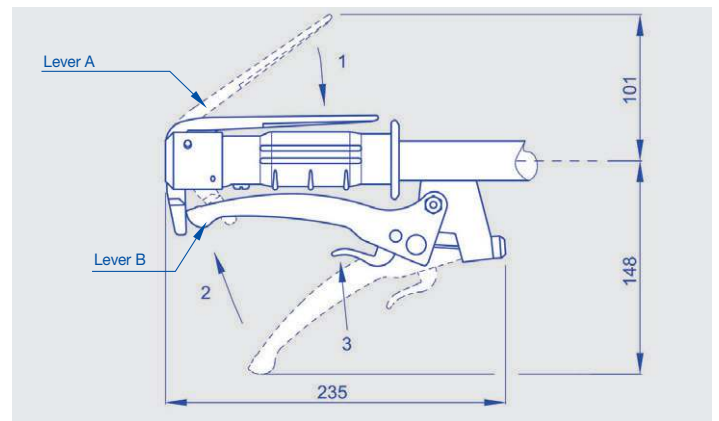

To order: compose, please, your product code inserting the boldfaced code corresponding to the chosen option in the proper square.

CL 10B [] [] [] [] [] []

"Normally open" microswitch : **01**
"Normally closed" microswitch: **02**

- Aluminium holder "A" with mm 18 "D" nib: **03**
- Aluminium holder "A" with mm 20 "D" nib: **04**
- Aluminium holder "A" with mm 21 "D" nib: **05**
- Aluminium holder "A" with mm 21,7 "D" nib: **06**
- Aluminium holder "A" with mm 22 "D" nib: **07**
- Aluminium holder "A" with mm 22,7 "D" nib: **08**
- Aluminium holder "A" with mm 25,8 "D" nib: **09**
- Aluminium holder "A" with mm 28 "D" nib: **10**
- Nylon holder "N" with mm 18 "D" nib: **11**
- Nylon holder "N" with mm 20 "D" nib: **12**
- Nylon holder "N" with mm 21 "D" nib: **13**
- Nylon holder "N" with mm 22 "D" nib: **14**
- Nylon holder "N" with mm 23 "D" nib: **15**

- Tube outer Ø mm 22: **16**
- Tube outer Ø mm 26: **17**
- Tube outer Ø mm 27: **18**
- Tube outer Ø mm 28: **19**

- Holder to be soldered: **S**
- Metal hose clamp for outer tube Ø mm 22: **F1**
- Right metal hose clamp for outer tube Ø mm 26: **D1**
- Right metal hose clamp for outer tube Ø mm 27: **D2**
- Right metal hose clamp for outer tube Ø mm 28: **D3**
- Left metal hose clamp for outer tube Ø mm 26: **S1**
- Left metal hose clamp for outer tube Ø mm 27: **S2**
- Left metal hose clamp for outer tube Ø mm 28: **S3**

Note: Microswitch = "normally open" for internal combustion engine; "normally closed" for electric engine. The characteristic of the microswitch "normally open" or "normally closed" is meant with the lever leant on the knob (lowered lever). **Nib diameter for lever A:** with holder in aluminium to be inserted inside the tube (mm): 18 - 20 - 21 - 21,7 - 22 - 22,7 - 25,8 - 28; with holder in nylon to be inserted inside the tube (mm): 18 - 20 - 21 - 22 - 23. **Knob:** shaped for assembly on tubes supplied in support of.



COMBINED ELECTRIC / MECHANICAL CONTROLS COMPATIBLE WITH UPPER LEVER ELECTRIC CABLES MODEL CL 10B

Characteristics of compatible electric cables for lever "A":

- Cable outer diameter: Ø5,5 mm
- Cable length: upon request
- Wires diameter: Ø2x0,75 mm
- Wires stripping length: upon request
- Wires terminals: see table

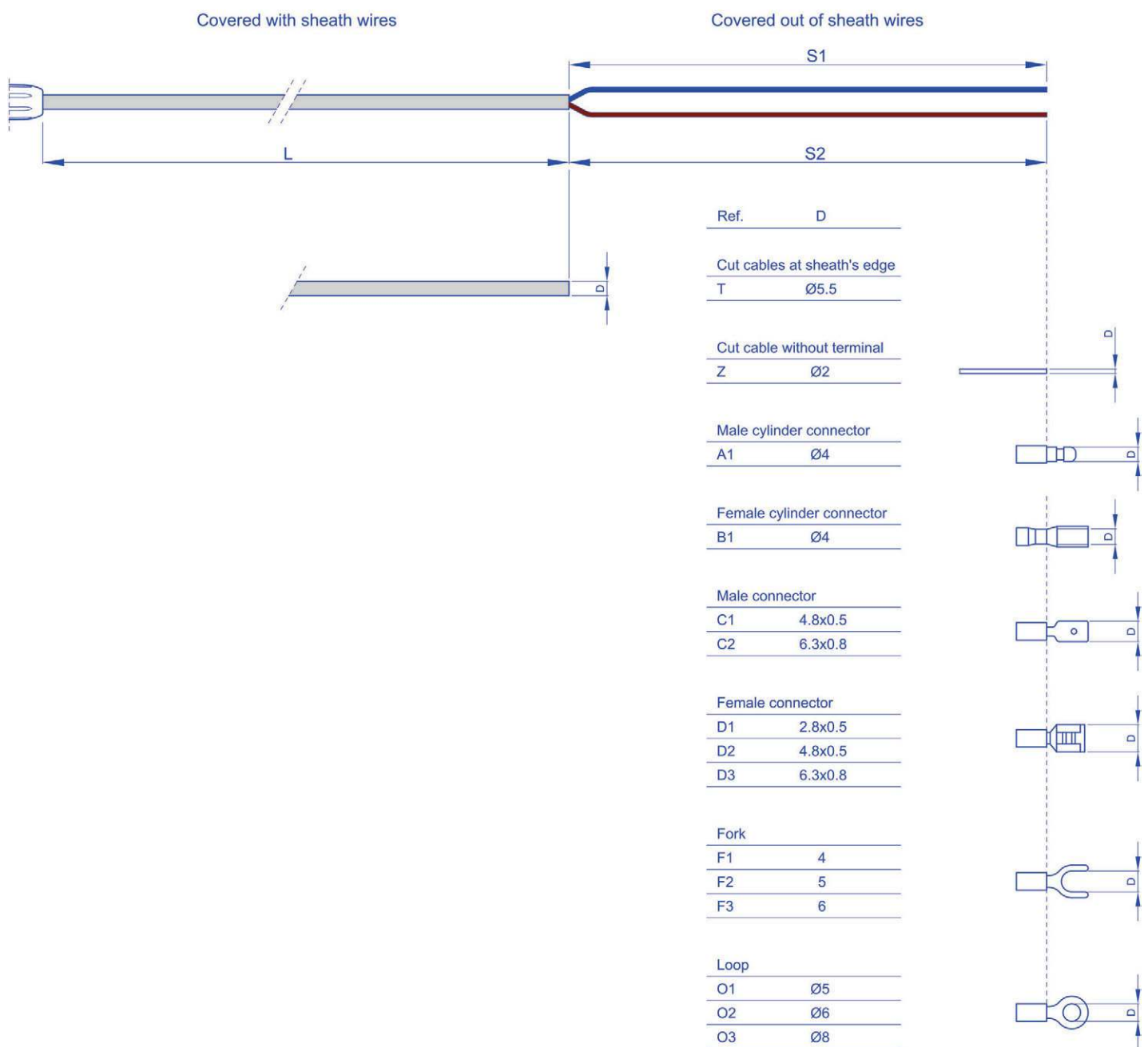



COMBINED ELECTRIC / MECHANICAL CONTROLS ORDER FORM FOR COMPATIBLE WITH UPPER LEVER ELECTRIC CABLES MODEL CL 10B

To order:

The technical options that are represented on the opposite page are the standard personalizations which are provided from the company.

Among these possibilities, you can choose the cable construction that meets your requirements.

At first choose if you want the covered wire only cut or the stripped wires and eventually select the corresponding terminals among the possible options.

Find out your preferences and fill in the boxes with the number or the letters/number corresponding to your options.

Example: if you choose the stripped wires and you want a loop on the blue wire as terminal, indicate the code 12 or 13 or 14, according to your needs.

And so on for other variables.

The same procedure must be used for the brown wire and then select the corresponding options.

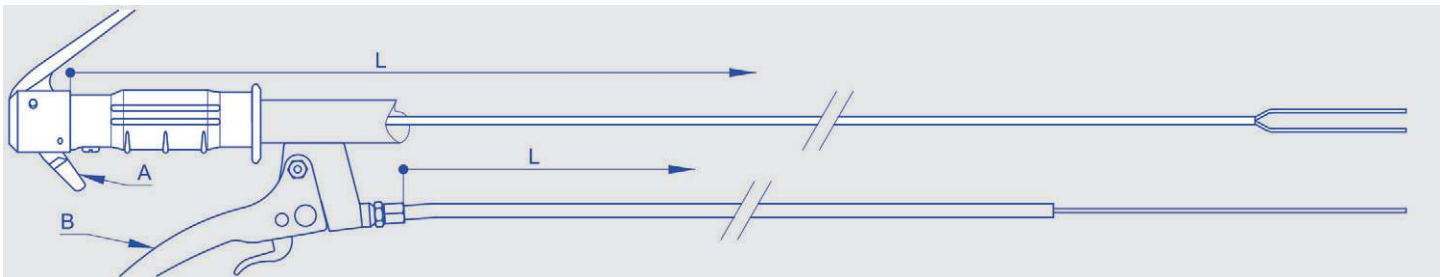

To order: compose, please, your product code inserting the boldfaced code corresponding to the chosen option in the proper square.

CL 10B - Lever A cable	Cut cables at sheath's edge (T)		Blue covered cable		
			Brown covered cable		

Covered with sheath cables length (L) in mm: _____	Brown out of sheath wire length (S2) in mm: _____
--	---

Covered out of sheath wire Z: 01 _____ Male cylinder connector A1: 02 _____ Female cylinder connector B1: 03 _____ Male connector C1: 04 _____ Male connector C2: 05 _____ Female connector D1: 06 _____ Female connector D2: 07 _____ Female connector D3: 08 _____ Fork F1: 09 _____ Fork F2: 10 _____ Fork F3: 11 _____ Loop O1: 12 _____ Loop O2: 13 _____ Loop O3: 14 _____	Covered out of sheath wire Z: 15 _____ Male cylinder connector A1: 16 _____ Female cylinder connector B1: 17 _____ Male connector C1: 18 _____ Male connector C2: 19 _____ Female connector D1: 20 _____ Female connector D2: 21 _____ Female connector D3: 22 _____ Fork F1: 23 _____ Fork F2: 24 _____ Fork F3: 25 _____ Loop O1: 26 _____ Loop O2: 27 _____ Loop O3: 28 _____
---	---

Blue out of sheath wire length (S1) in mm: _____	
--	--



COMBINED ELECTRIC / MECHANICAL CONTROLS COMPATIBLE WITH LOWER LEVER CABLES MODEL CL 10B

Characteristics of compatible cables for lever "B":

- Sheath diameter: Ø6 mm or Ø7 mm with inner antifriction tube
- Sheath length: upon request
- Wire diameter: Ø1,9 mm or Ø2,5 mm
- Wire protrusion length: upon request
- Sheath terminals: see table
- Wire terminals: see table

Sheath options

Wire options

Ref.	Sheath Ø	A	B	C	D	Terminal	
Sheath							
G1	6	(Only cut end)					
G2	7	(Only cut end)					
Sleeve with nib							
B1	6	20	5.9	7	8	Pressed	
B2	6	23	6.3	11	9	Pressed	
B3	7	17	5.8	6	10	Pressed	
B4	7	23	6.3	11	9	Pressed	
End cap							
C1	6	10	7			Pressed	
C2	7	10.5	8			Pressed	
Adjustment screw 1 nut							
D1	6	30	M6	21		Turning	
D2	6	40	M8	28		Turning	
D3	7	30	M6	21		Turning	
D4	7	40	M8	28		Turning	
Adjustment screw 2 nuts							
RG1	6	40	M6	30		Turning	
RG2	6	40	M8	28		Turning	
RG3	7	40	M6	30		Turning	
RG4	7	40	M8	28		Turning	
Adjustment screw 2 nuts							
RP1	6	40	M6	30		Pressed	
RP2	6	40	M8	28		Pressed	
RP3	7	40	M6	30		Pressed	
RP4	7	40	M8	28		Pressed	

Ref.	Wire Ø	A	B	C	D
Wire					
E1	1.9	(Only electro-welded end)			
E2	2.5	(Only electro-welded end)			
Fork					
F1	1.9	30	6	12	6
F2	1.9	38	6	24	6
F3	2.5	30	6	12	6
F4	2.5	38	6	24	6
F5	2.5	34	8	16	8
Spring					
M1	1.9	46	2.2	12	
M2	1.9	55	3	15	
M3	2.5	57	3.5	16	
Loop					
O1	1.9	23	5.2	10.6	
O2	1.9	23	6.2	10.6	
O3	1.9	31	6.2	12	
O4	1.9	32	8.3	16	
O5	1.9	32	10.2	16	
O6	2.5	31	6.2	12	
O7	2.5	32	8.3	16	
O8	2.5	32	10.2	16	
Threaded pin					
P1	1.9	44	M6	20	
P2	1.9	74	M6	46	
P3	2.5	44	M6	20	
P4	2.5	74	M6	46	
P5	2.5	49	M8	25	
Zed bend					
Z1	1.9	26	4	15	14.5



COMBINED ELECTRIC / MECHANICAL CONTROLS ORDER FORM FOR COMPATIBLE WITH LOWER LEVER CABLES MODEL CL 10B

To order:

The technical options that are represented on the opposite page are the standard personalizations which are provided from the company.

Among these possibilities, you can choose the cable construction that meets your requirements.

At first choose the sheath diameter and select the corresponding terminals among the possible options.

Find out your preferences and fill in the boxes with the number or the letters/number corresponding to your options.

Example: if you choose a Ø7 mm sheath and you want a sleeve with nib as terminal, indicate the code 05 or 06, according to your needs.

And so on for other variables.

The same procedure must be used to choose the wire: start choosing the diameter and then select the corresponding options.

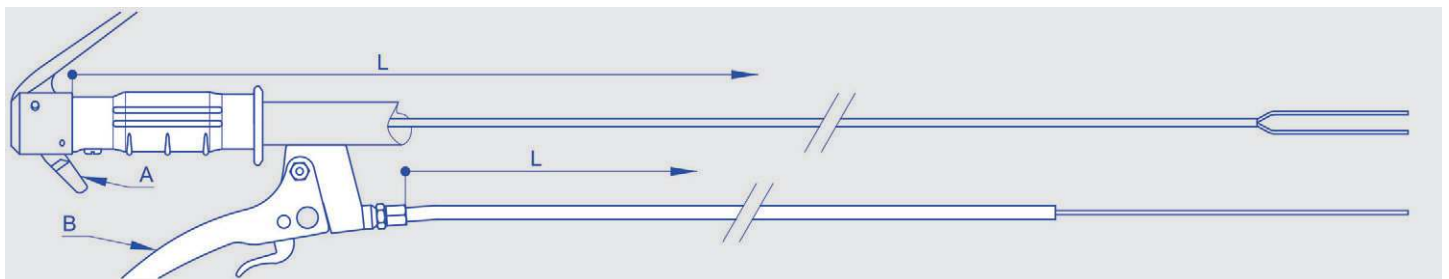

To order: compose, please, your product code inserting the boldfaced code corresponding to the chosen option in the proper square.

CL 10B - Lever B cable

<p>Sheath length (L) in mm: _____</p> <p>Wire protrusion length (S) in mm: _____</p> <p>Sheath Ø6 mm (only cut) G1: 01</p> <p>Sheath Ø7 mm (only cut) G2: 02</p> <p>Sleeve with nib B1: 03</p> <p>Sleeve with nib B2: 04</p> <p>Sleeve with nib B3: 05</p> <p>Sleeve with nib B4: 06</p> <p>End cap C1: 07</p> <p>End cap C2: 08</p> <p>Adjustment screw 1 nut D1: 09</p> <p>Adjustment screw 1 nut D2: 10</p> <p>Adjustment screw 1 nut D3: 11</p> <p>Adjustment screw 1 nut D4: 12</p> <p>Turning adjustment screw 2 nuts RG1: 13</p> <p>Turning adjustment screw 2 nuts RG2: 14</p> <p>Turning adjustment screw 2 nuts RG3: 15</p> <p>Turning adjustment screw 2 nuts RG4: 16</p> <p>Pressed adjustment screw 2 nuts RP1: 17</p> <p>Pressed adjustment screw 2 nuts RP2: 18</p> <p>Pressed adjustment screw 2 nuts RP3: 19</p> <p>Pressed adjustment screw 2 nuts RP4: 20</p>	<p>Only electro-welded wire Ø1,9 mm without terminal E1: 21</p> <p>Only electro-welded wire Ø2,5 mm without terminal E2: 22</p> <p>Fork F1: 23</p> <p>Fork F2: 24</p> <p>Fork F3: 25</p> <p>Fork F4: 26</p> <p>Fork F5: 27</p> <p>Spring M1: 28</p> <p>Spring M2: 29</p> <p>Spring M3: 30</p> <p>Loop O1: 31</p> <p>Loop O2: 32</p> <p>Loop O3: 33</p> <p>Loop O4: 34</p> <p>Loop O5: 35</p> <p>Loop O6: 36</p> <p>Loop O7: 37</p> <p>Loop O8: 38</p> <p>Threaded pin P1: 39</p> <p>Threaded pin P2: 40</p> <p>Threaded pin P3: 41</p> <p>Threaded pin P4: 42</p> <p>Threaded pin P5: 43</p> <p>Zed bend Z1: 44</p>
--	---

L = start point for sheath length. Other cables typologies are available upon request.