

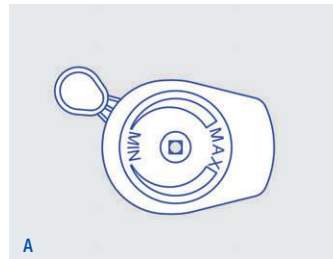

# LATERAL MECHANICAL CONTROLS WITH TRACTION AND COMPRESSION ACTING WITH DIRECT ACTING (light loads applications - double cable) AND ORDER FORM MODEL AE 250SD

### Characteristics:

- Cable linear stroke: 39 or 46 mm
- Assembly: on tubes
- Fastening type: with through screw
- Tube outer diameter: 22 mm - 25 mm - 26 mm - 27 mm - 28 mm
- Functioning: frictioned or jerkily with 4 positioning marks
- Material: nylon Colour: black
- Writing on the cover: MIN-MAX or STOP-MIN-MAX-START

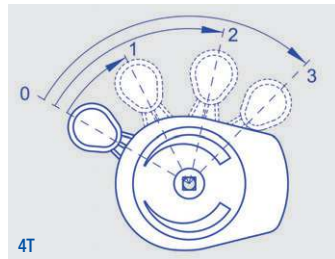
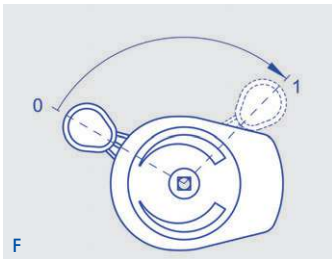
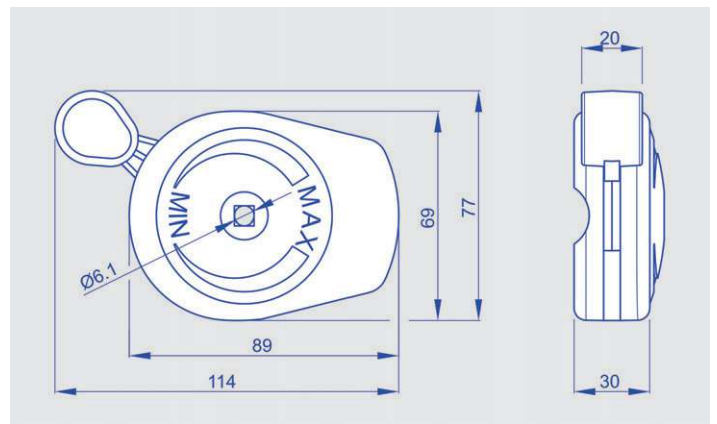

To order: compose, please, your product code inserting the boldfaced code corresponding to the chosen option in the proper square.

AE 250DS

- Stroke mm 39: **1**
- Stroke mm 46: **2**

- Outer tube Ø mm 22: **3**
- Outer tube Ø mm 25: **4**
- Outer tube Ø mm 26: **5**
- Outer tube Ø mm 27: **6**
- Outer tube Ø mm 28: **7**

- Frictioned functioning: **F**
- Jerkily functioning with 4 positioning marks: **4T**

- Writing MIN-MAX: **A**
- Writing STOP-MIN-MAX-START: **B**



## LATERAL MECHANICAL CONTROLS COMPATIBLE CABLES MODEL AE 250SD

### Characteristics:

- Sheath diameter: Ø5 mm or Ø6 mm with inner antifriction tube
- Sheath length: upon request
- Rigid wire diameter: Ø1,5 mm or Ø1,7 mm in phosphated steel (\*)
- Wire protrusion length: upon request
- Sheath terminals: see table
- Wire terminals: see table

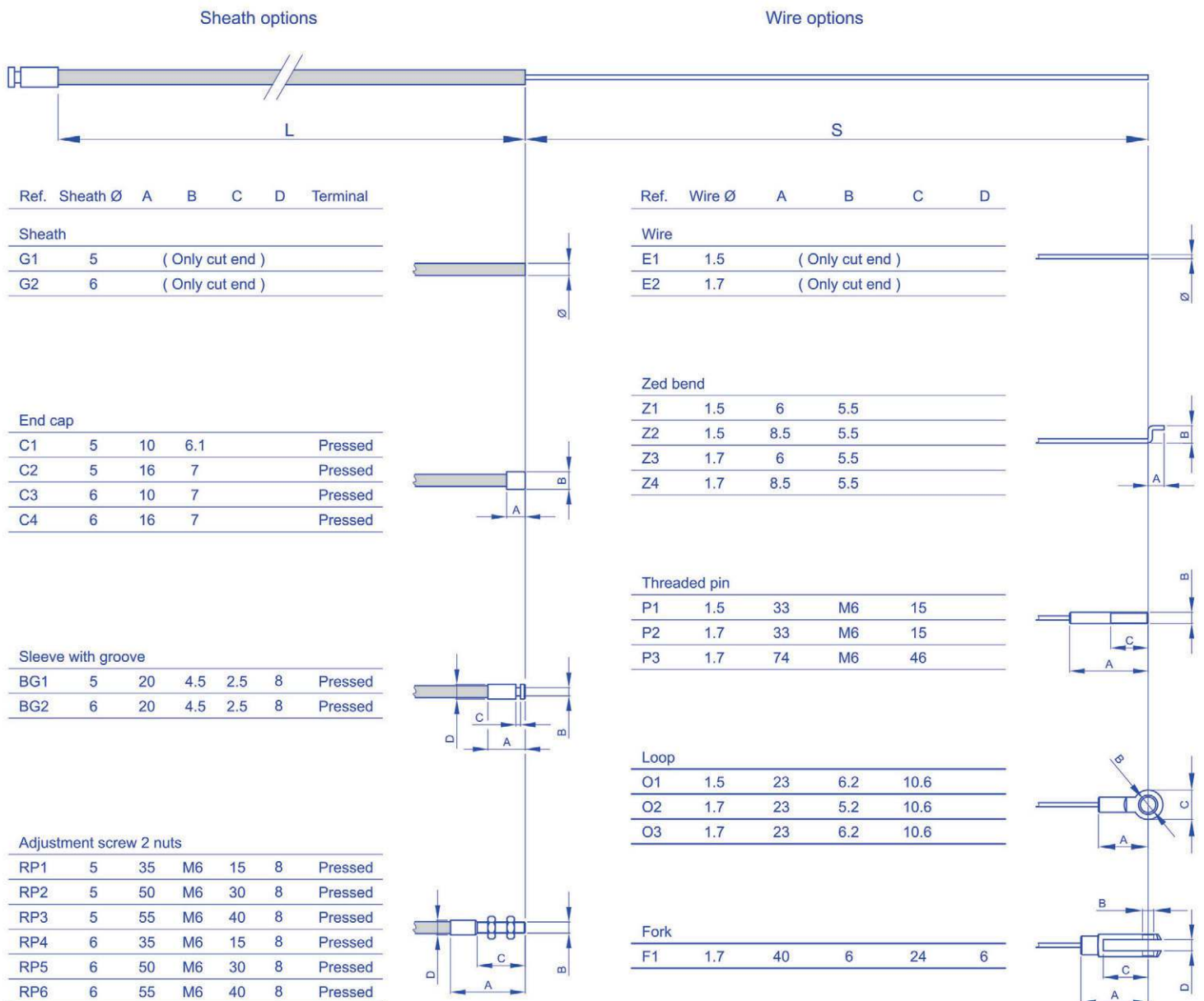



## LATERAL MECHANICAL CONTROLS ORDER FORM FOR COMPATIBLE CABLES MODEL AE 250SD

**To order:**

The technical options that are represented on the opposite page are the standard personalizations which are provided from the company.

Among these possibilities, you can choose the cable construction that meets your requirements.

At first choose the sheath diameter and select the corresponding terminals among the possible options.

Find out your preferences and fill in the boxes with the number or the letters/number corresponding to your options.

Example: if you choose a Ø6 mm sheath and you want an end cap as terminal, indicate the code 05 or 06, according to your needs.

And so on for other variables.

The same procedure must be used to choose the wire: start choosing the diameter and then select the corresponding options.

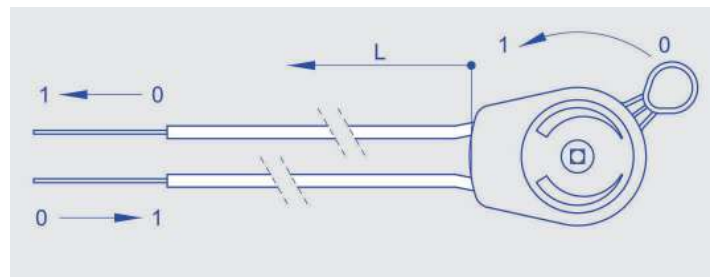
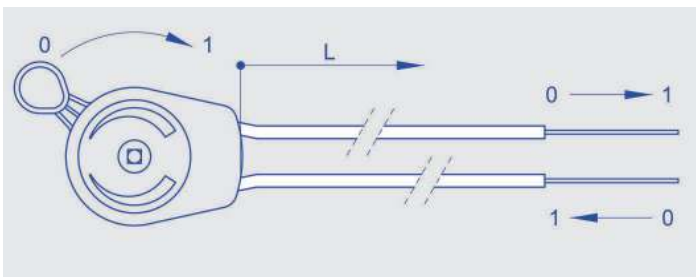

**To order: compose, please, your product code inserting the boldfaced code corresponding to the chosen option in the proper square.**

Cable									
-------	--	--	--	--	--	--	--	--	--

Sheath length (L) in mm: \_\_\_\_\_  
Wire protrusion length (S) in mm: \_\_\_\_\_

Sheath Ø5 mm (only cut) G1: **01**  
Sheath Ø6 mm (only cut) G2: **02**

End cap C1: **03**  
End cap C2: **04**  
End cap C3: **05**  
End cap C4: **06**

Sleeve with groove BG1: **07**  
Sleeve with groove BG2: **08**

Pressed adjustment screw 2 nuts RP1: **09**  
Pressed adjustment screw 2 nuts RP2: **10**  
Pressed adjustment screw 2 nuts RP3: **11**  
Pressed adjustment screw 2 nuts RP4: **12**  
Pressed adjustment screw 2 nuts RP5: **13**  
Pressed adjustment screw 2 nuts RP6: **14**

Cable assembly: **PA1**  
Cable assembly: **PA2**  
Cable assembly: **PA3**  
Cable assembly: **PA4**  
Cable assembly: **PA5**  
Cable assembly: **PA6**  
Cable assembly: **PA7**  
Cable assembly: **PA8**

Only cut rigid wire Ø1,5 mm without terminal E1: **15**  
Only cut rigid wire Ø1,7 mm without terminal E2: **16**

Zed bend Z1: **17**  
Zed bend Z2: **18**  
Zed bend Z3: **19**  
Zed bend Z4: **20**

Threaded pin P1: **21**  
Threaded pin P2: **22**  
Threaded pin P3: **23**

Loop O1: **24**  
Loop O2: **25**  
Loop O3: **26**

Fork F1: **27**